

ALTON / FANN

CABINETS / TV CABINETS
SZAFKI / SZAFKI TV



ALTON FREESTANDING CABINETS
SZAFKI ALTON WOLNOSTOJ CE



ALTON MODULAR CABINETS
SZAFKI ALTON MODUŁOWE



FANN RTV CABINETS
SZAFKI RTV FANN

CABINETS LENGTH DŁUGO SZAFEK	150 CM / 200 CM / 250 CM	50 CM	120 CM / 160 CM / 200 CM / 240 CM
CABINETS DEPTH GŁĘBOKO SZAFEK	40 CM	40 CM	30 CM / 40 CM / 50 CM
CABINETS HEIGHT WYSOKO SZAFEK	50 CM	40 CM	25 CM / 40 CM
LACQUERED AND TEXTURED BOARD PŁYTA LAKIEROWANA I STRUKTURALNA	●	●	●
QUARTZ SINTERS SPIEKI CERAMICZNE	TOP OF CABINETS NA SZAFCE		TOP AND SIDES OF CABINETS NA BLACIE I BOKACH
FRONTS FRONTY	●	●	●
REEDED FRONTS FRONTY RYFLOWANE	●	●	
FRONTS / ALUMINUM FLAPS WITH GLASS FRONTY / KLAPY ALUMINIOWE Z SZKŁEM			●
OPENING FLAPS KLAPY OTWIERANE			●
DRAWERS SZUFLADY			●
CABINETS ON LEGS (HIGH) SZAFKI NA NÓ KACH (WYSOKO CI)	H - 13 / 23 CM	H - 23 / 30 / 35 / 45 CM	H - 23 CM
STRAIGHT LEGS NÓ KI PROSTE	●	●	●
ANGLED LEGS NÓ KI SKO NE		●	
CABINETS ON FEET SZAFKAI NA STOPKACH		●	●
STANDING CABINETS SZAFKI STOJ CE	●	●	●
HANGING CABINETS SZAFKI WISZ CE			●

ALTON

ALTON FREESTANDING CABINETS SZAFKI ALTON WOLNOSTOJ CE

ALTON furniture is a collection for real connoisseurs who appreciate the beauty of details in interior design. It is furniture that will suit your needs. The cabinets complementing the collection, thanks to their various configurations, will ensure incredible freedom in interior design. The ALTON desk is complemented by modular cabinets, which allow you to adjust the functionality of the furniture to suit your needs. In addition, the fluted fronts of the ALTON cabinets have been given a chic, slightly minimalist, yet eye-catching form. It is the perfect piece of furniture for interiors where sophisticated design counts in addition to high-quality furniture.

Meble ALTON to kolekcja dla prawdziwych koneserów, którzy w aranacji w trz cenipi kno detali. To meble, które dopasuj si Twoich potrzeb. Szafki b d ce uzupełnieniem kolekcji poprzez ró ne mo liwo ci konfiguracji zapewni niebywał wprost swobod w aranacji w trza. Uzupełnieniem biurka ALTON b d modułarne szafki, które pozwalaj dopasowa funkcjonalno mebli odpowiednio do swoich potrzeb. Dodatkowo ryflowane fronty szafek ALTON zyskały w ten sposób szykowń form, nieco minimalistyczn, a jednocze nie przyci gaj c wzrok. To doskonały mebel do wn trz, w których oprócz wysokiej jako ci mebli liczy si równie wysmakowany design.



ALT-SZA-Z14-H25-BS





ALT-SZA-Z14-H25-BP





ALT-SZA-Z14-H13-BS





ALT-SZA-Z14-H25-BP





ALT-SZA-Z13-H13-BS





ALT-SZA-S13-H25-BS





ALT-SZA-S14-H25-BS





ALT-SZA-Z13-H13-BS





ALT-SZA-S14-H13-BS



Alton cabinets have the option of a ceramic sintered or laminated board top.

Szafki Alton mają możliwość zastosowania blatu górnego w opcji ze spiekem ceramicznym lub płyt laminowaną.

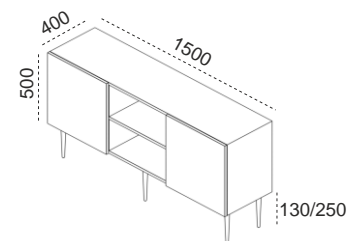
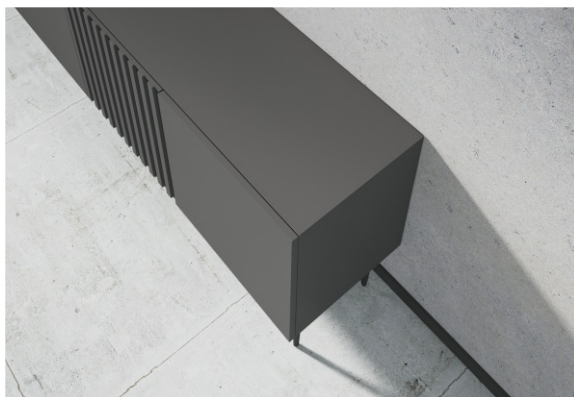

ALT-SZA-Z12-H13 ALT-SZA-S12-H13
ALT-SZA-Z12-H25 ALT-SZA-S12-H25

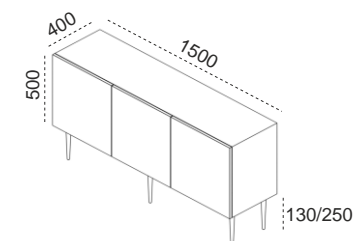

ALT-SZA-Z15-H13 ALT-SZA-S15-H13
ALT-SZA-Z15-H25 ALT-SZA-S15-H25

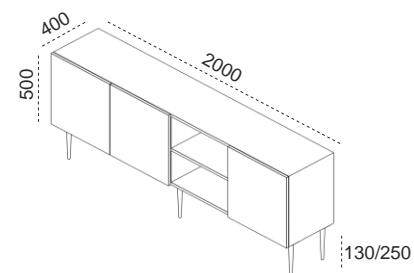

ALT-SZA-Z13-H13 ALT-SZA-S13-H13
ALT-SZA-Z13-H25 ALT-SZA-S13-H25

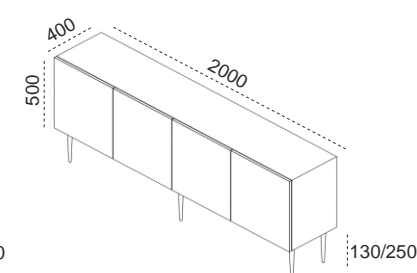

ALT-SZA-Z16-H13 ALT-SZA-S16-H13
ALT-SZA-Z16-H25 ALT-SZA-S16-H25

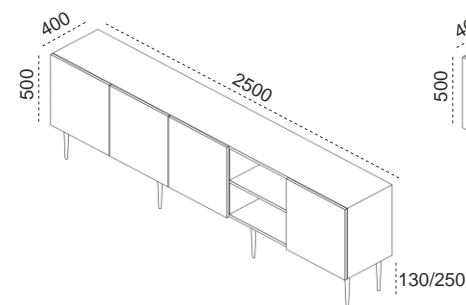

ALT-SZA-Z14-H13 ALT-SZA-S14-H13
ALT-SZA-Z14-H25 ALT-SZA-S14-H25

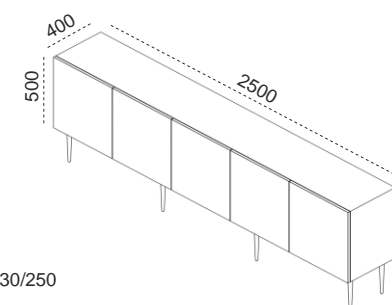

ALT-SZA-Z17-H13 ALT-SZA-S17-H13
ALT-SZA-Z17-H25 ALT-SZA-S17-H25

The legs of the cabinets come in two heights:
 13 cm and 25 cm
*Nó ki w szafkach wyst puj w dwóch wysoko ciach:
 13 cm oraz 25 cm*

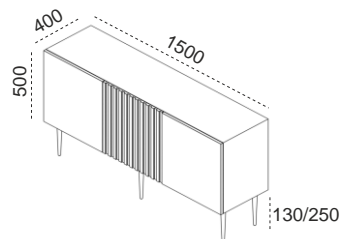

ALT-SZA-Z18-H13 ALT-SZA-S18-H13
 ALT-SZA-Z18-H25 ALT-SZA-S18-H25

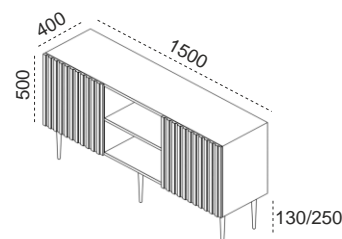

ALT-SZA-Z21-H13 ALT-SZA-S21-H13
 ALT-SZA-Z21-H25 ALT-SZA-S21-H25

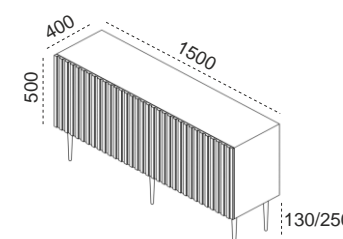

ALT-SZA-Z24-H13 ALT-SZA-S24-H13
 ALT-SZA-Z24-H25 ALT-SZA-S24-H25

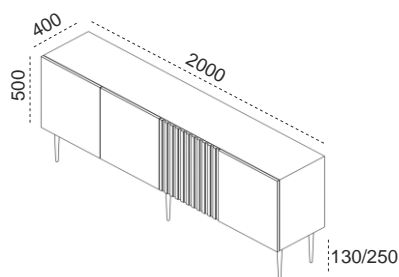

ALT-SZA-Z19-H13 ALT-SZA-S19-H13
 ALT-SZA-Z19-H25 ALT-SZA-S19-H25

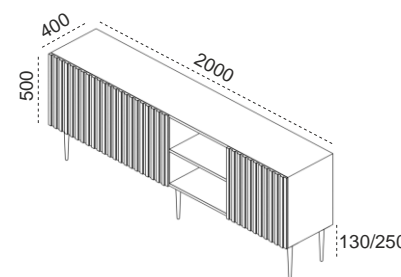

ALT-SZA-Z22-H13 ALT-SZA-S22-H13
 ALT-SZA-Z22-H25 ALT-SZA-S22-H25

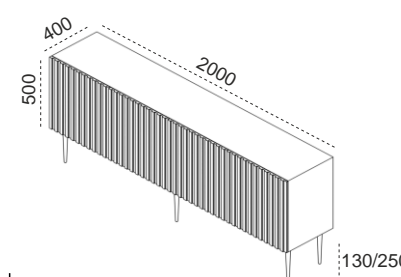

ALT-SZA-Z25-H13 ALT-SZA-S25-H13
 ALT-SZA-Z25-H25 ALT-SZA-S25-H25

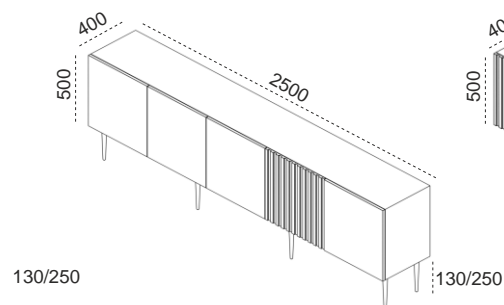

ALT-SZA-Z20-H13 ALT-SZA-S20-H13
 ALT-SZA-Z20-H25 ALT-SZA-S20-H25

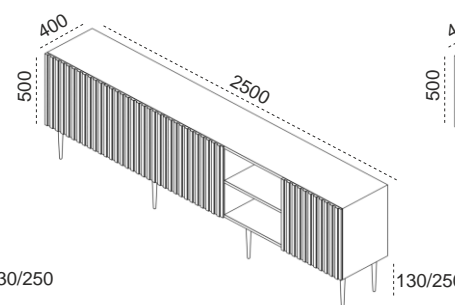

ALT-SZA-Z23-H13 ALT-SZA-S23-H13
 ALT-SZA-Z23-H25 ALT-SZA-S23-H25

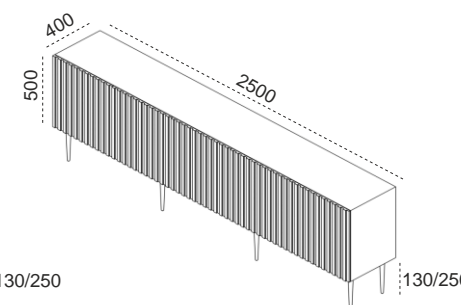

ALT-SZA-Z26-H13 ALT-SZA-S26-H13
 ALT-SZA-Z26-H25 ALT-SZA-S26-H25

**JOINING OF THE CABINET BODY 45 DEGREES
Ł CZENIE KORPUSU SZAFKI 45 STOPNI**



**CERAMIC SINTER AS THE TOP OF THE CABINET
SPIEK CERAMICZNY JAKO BLAT SZAFKI**



**CERAMIC SINTER AS A TOP AND SIDES OF THE CABINET
- CONNECTING 45 DEGREES
SPIEK CERAMICZNY JAKO BLAT ORAZ BOKI SZAFKI
- Ł CZENIE 45 STOPNI**



**INTERNAL ELEMENTS OF THE CABINET MADE OF MATT
LAMINATED BOARD IN COLOR GRAPHITE OR BLACK**

*ELEMENTY WEWN TRZNE SZAFKI WYKONANE
Z MATOWEJ PŁYTA LAMINOWANEJ W KOLORZE
GRAFITOWYM LUB CZARNYM*



**INTERNAL ELEMENTS OF THE CABINET MADE OF MATT
LAMINATED BOARD IN COLOR GRAPHITE OR BLACK**

*ELEMENTY WEWN TRZNE SZAFKI WYKONANE
Z MATOWEJ PŁYTA LAMINOWANEJ W KOLORZE
GRAFITOWYM LUB CZARNYM*



**INTERNAL ELEMENTS OF THE CABINET MADE OF MATT
LAMINATED BOARD IN COLOR GRAPHITE OR BLACK**

*ELEMENTY WEWN TRZNE SZAFKI WYKONANE
Z MATOWEJ PŁYTA LAMINOWANEJ W KOLORZE
GRAFITOWYM LUB CZARNYM*









BASIC MODULE FOR ARRANGING EXTENDED SETS

MODUŁ PODSTAWOWY DO UKŁADANIA ROZBUDOWANYCH ZESTAWÓW

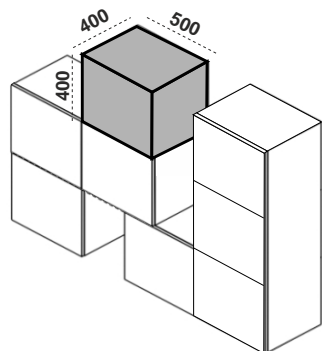

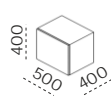
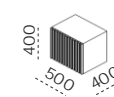
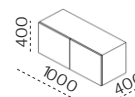
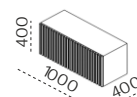
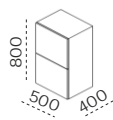
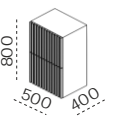
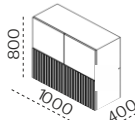
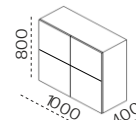
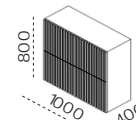
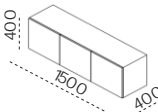
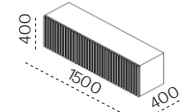
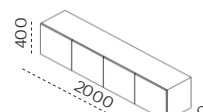
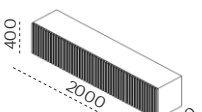
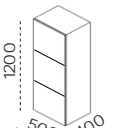
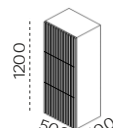
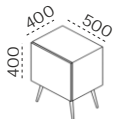
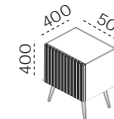
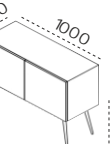
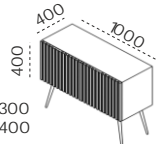
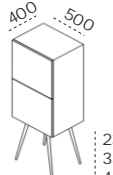
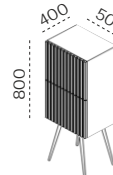
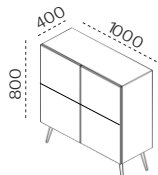
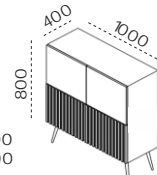
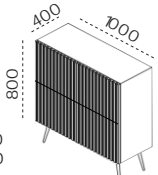
 ALT-SZA-Z01 ALT-SZA-S01	 ALT-SZA-Z01-L1	 ALT-SZA-Z02 ALT-SZA-S02	 ALT-SZA-Z02-L1	 ALT-SZA-Z03 ALT-SZA-S03	 ALT-SZA-Z03-L1	 ALT-SZA-Z04-L1	 ALT-SZA-Z04 ALT-SZA-S04	 ALT-SZA-Z04-L2
		 ALT-SZA-Z05 ALT-SZA-S05	 ALT-SZA-Z05-L1	 ALT-SZA-Z06 ALT-SZA-S06	 ALT-SZA-Z06-L1	 ALT-SZA-Z07 ALT-SZA-S07	 ALT-SZA-Z07-L1	
 ALT-SZA-Z01-H23 230/300 350/400 450	 ALT-SZA-Z01-H23-L1 230/300 350/400 450	 ALT-SZA-Z02-H23 230/300 350/400 450	 ALT-SZA-Z02-H23-L1 230/300 350/400 450	 ALT-SZA-Z03-H23 230/300 350/400 450	 ALT-SZA-Z03-H23-L1 230/300 350/400 450	 ALT-SZA-Z04-H23 230/300 350/400 450	 ALT-SZA-Z04-H23-L1 230/300 350/400 450	 ALT-SZA-Z04-H23-L2 230/300 350/400 450
ALT-SZA-Z01-H30	ALT-SZA-Z01-H30-L1	ALT-SZA-Z02-H30	ALT-SZA-Z02-H30-L1	ALT-SZA-Z03-H30	ALT-SZA-Z03-H30-L1	ALT-SZA-Z04-H30	ALT-SZA-Z04-H30-L1	ALT-SZA-Z04-H30-L2
ALT-SZA-Z01-H35	ALT-SZA-Z01-H35-L1	ALT-SZA-Z02-H35	ALT-SZA-Z02-H35-L1	ALT-SZA-Z03-H35	ALT-SZA-Z03-H35-L1	ALT-SZA-Z04-H35	ALT-SZA-Z04-H35-L1	ALT-SZA-Z04-H35-L2
ALT-SZA-Z01-H40	ALT-SZA-Z01-H40-L1	ALT-SZA-Z02-H40	ALT-SZA-Z02-H40-L1	ALT-SZA-Z03-H40	ALT-SZA-Z03-H40-L1	ALT-SZA-Z04-H40	ALT-SZA-Z04-H40-L1	ALT-SZA-Z04-H40-L2
ALT-SZA-Z01-H45	ALT-SZA-Z01-H45-L1	ALT-SZA-Z02-H45	ALT-SZA-Z02-H45-L1	ALT-SZA-Z03-H45	ALT-SZA-Z03-H45-L1	ALT-SZA-Z04-H45	ALT-SZA-Z04-H45-L1	ALT-SZA-Z04-H45-L2
ALT-SZA-S01-H23		ALT-SZA-S02-H23		ALT-SZA-S03-H23		ALT-SZA-S04-H23		
ALT-SZA-S01-H30		ALT-SZA-S02-H30		ALT-SZA-S03-H30		ALT-SZA-S04-H30		
ALT-SZA-S01-H35		ALT-SZA-S02-H35		ALT-SZA-S03-H35		ALT-SZA-S04-H35		
ALT-SZA-S01-H40		ALT-SZA-S02-H40		ALT-SZA-S03-H40		ALT-SZA-S04-H40		
ALT-SZA-S01-H45		ALT-SZA-S02-H45		ALT-SZA-S03-H45		ALT-SZA-S04-H45		

EXAMPLES OF LAYOUTS USING MODULAR CABINET / PRZYKŁADY UKŁADÓW Z WYKORZYSTANIEM SZAFEK MODUŁOWYCH

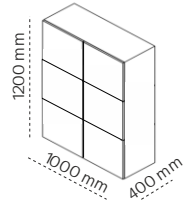
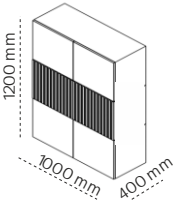
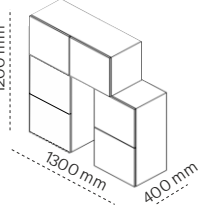
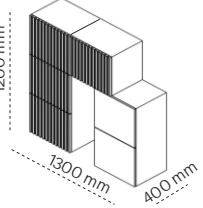
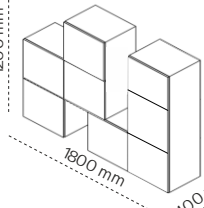
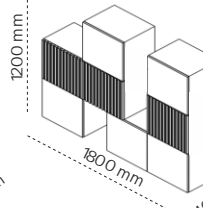
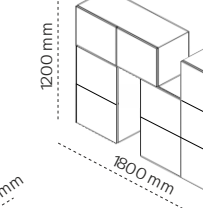
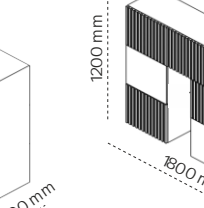
 ALT-SZA-Z08	 ALT-SZA-Z08-L1	 ALT-SZA-Z09	 ALT-SZA-Z09-L1	 ALT-SZA-Z10	 ALT-SZA-Z10-L1	 ALT-SZA-Z11	 ALT-SZA-Z11-L1
--	---	--	--	--	---	--	---

FANN

FANN RTV CABINETS
SZAFKI RTV FANN

The FANN TV cabinet collection offers high functionality, allowing the organization and storage of various electronic devices and media in an aesthetic and orderly manner. Designed with space optimization in mind, FANN cabinets facilitate the efficient and aesthetically pleasing arrangement of AV equipment. The combination of modern design with classical accents gives the FANN cabinet collection a unique charm. Elegant lines, carefully crafted details, and diverse material configuration options, including soft-touch lacquered panels, structured panels, glass, and quartz conglomerates, enable the creation of a space that seamlessly blends with various interior styles.

Kolekcja szafek RTV FANN zapewnia dużą funkcjonalność, umożliwiając organizację i przechowywanie różnorodnych urządzeń elektronicznych oraz mediów w sposób estetyczny i uporządkowany. Zaprojektowane z myślą o optymalizacji przestrzeni, szafki FANN umożliwiają sprawną i estetyczną aranżację sprzętu RTV. Kombinacja nowoczesnego designu z akcentami klasyki nadaje kolekcji szafek FANN unikalnego uroku. Eleganckie linie, starannie wykonane detale oraz zróżnicowane możliwości konfiguracji materiałowej: płyty lakierowane soft-touch, płyty w strukturze, szkła i spieków kwarcowych pozwalają na stworzenie przestrzeni, która harmonijnie łączy się z różnorodnymi stylami aranżacyjnymi.



500x1600x400 / PLA-17AV - PLA-18



FANN

FANN RTV CABINET / SZAFKI RTV FANN



FANN

FANN RTV CABINET / SZAFKI RTV FANN



FANN

FANN RTV CABINET / SZAFKI RTV FANN



FANN

FANN RTV CABINET / SZAFKI RTV FANN



FANN

FANN RTV CABINET / SZAFKI RTV FANN



STANDING TV CABINETS - OPENING FLAPS SZAFKI STOJ CE / KLAPY OTWIERANE

LEVELLING FOOT STE-01 - HEIGHT H 30
NA STOPKACH H-30

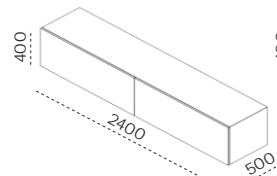
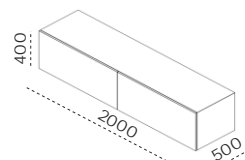
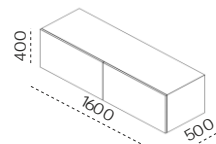
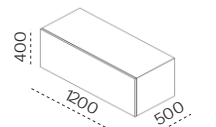
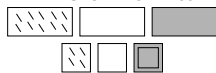

LEGS - HEIGHT H 230
NA NÓ KA H-230

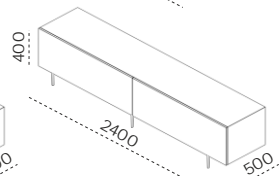
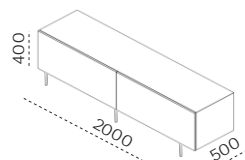
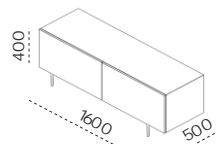
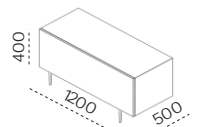
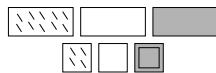

STANDING TV CABINETS - OPENING FRONTS SZAFKI STOJ CE / FRONTY OTWIERANE

LEVELLING FOOT STE-01 - HEIGHT H 30
NA STOPKACH H-30

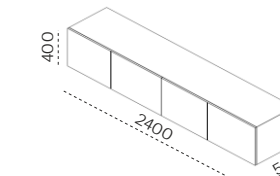
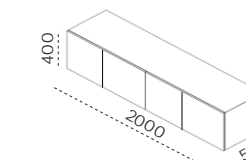
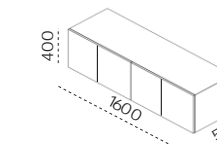
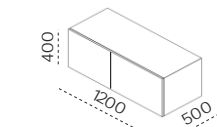

LEGS - HEIGHT H 230
NA NÓ KA H-230

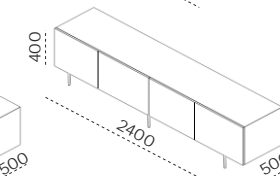
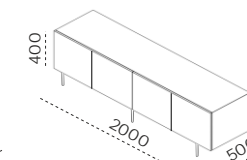
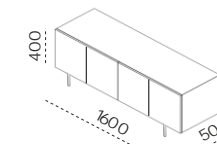
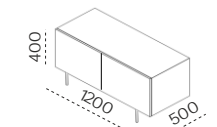
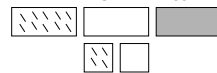

WALL-MOUNTED TV CABINETS - OPENING FLAPS SZAFKI WISZ CE KLAPY OTWIERANE

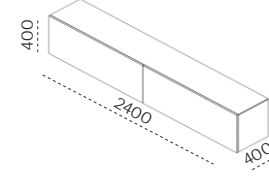
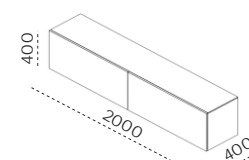
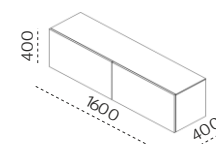
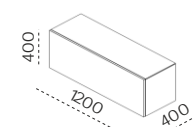
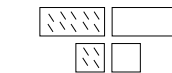

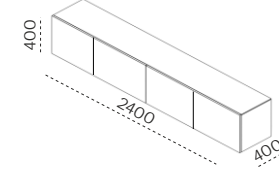
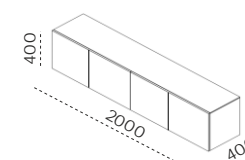
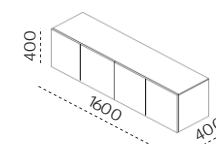
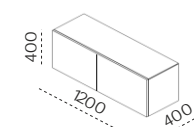
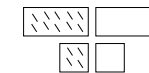

WALL-MOUNTED TV CABINETS - OPENING FRONTS SZAFKI WISZ CE FRONTY OTWIERANE



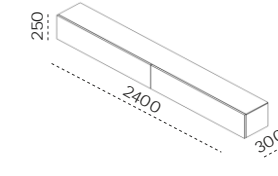
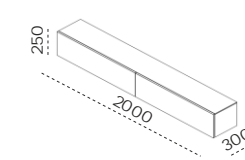
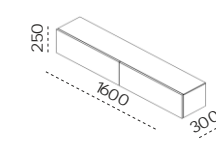
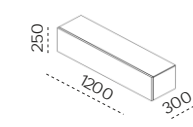
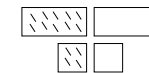

WALL-MOUNTED TV CABINETS - OPENING FLAPS SZAFKI WISZ CE KLAPY OTWIERANE



TOP AND SIDES OF CABINETS (TYPE OF MATERIAL) KORPUS (RODZAJ MATERIAŁU):

-  - STRUCTURED BOARD / PŁYTA W STRUKTURZE
-  - VARNISHED BOARD SOFT TOUCH / PŁYTA LAKIEROWANA SOFT TOUCH
-  - QUARTZ SINTER / SPIEK CERAMICZNY

OPENING FRONTS (TYPE OF MATERIAL) FRONT / KLAPA (RODZAJ MATERIAŁU):

-  - STRUCTURED BOARD / PŁYTA W STRUKTURZE
-  - VARNISHED BOARD SOFT TOUCH / PŁYTA LAKIEROWANA SOFT TOUCH
-  - COLORED MASS GLASS IN AN ALUMINIUM FRAME / SZKŁO BARWIONE W MASIE W RAMIE ALUMINIOWEJ

METAL HANGING SHELF PÓLKA WISZ CA METALOWA



MATERIALS / MATERIAŁY

STATUARIO VENATO **BSP-01**

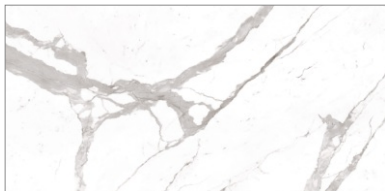

PIETRA DI SAVOIA GRIGIO **BSP-12**



INVISIBLE WHITE **BSP-18**



EMPERADOR EXTRA **BSP-22**

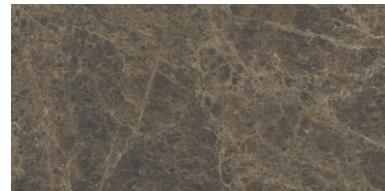

ADRESIA NERO **BSP-63**

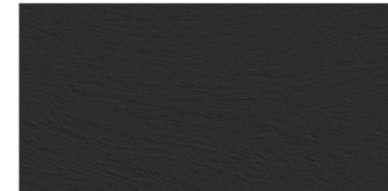

NOIR DESIR **BSP-05**

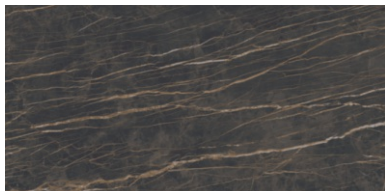

PIETRA DI SAVOIA ANTRACYT **BSP-13**



STATUARIETTO **BSP-19**

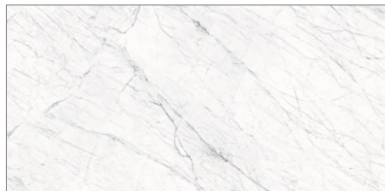

OSSIDO VERDERAME **BSP-24**

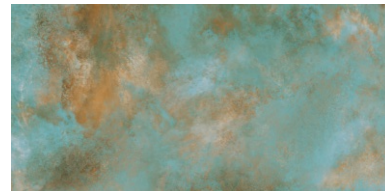

ADRESIA BIANCO **BSP-64**

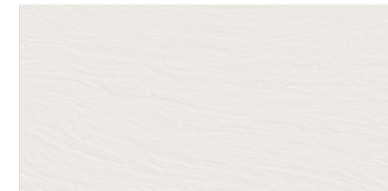

CALACATTA ORO VENATO **BSP-10**



OSSIDO NERO **BSP-14**

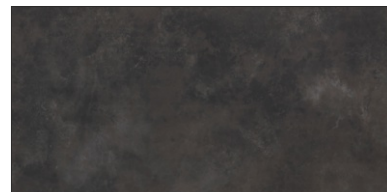

PIETRA GREY **BSP-20**

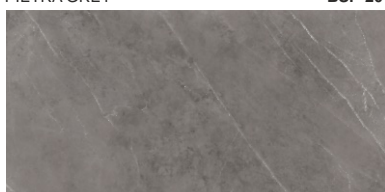

NATURE MOOD MOUNTAIN PEAK COMFORT **BSP-59 C**

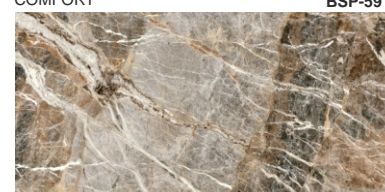

PIETRA DI SAVOIA PERLA **BSP-11**

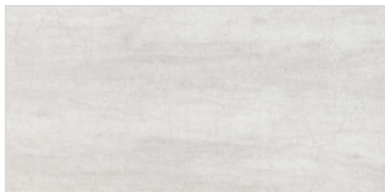

OSSIDO BRUNO **BSP-15**

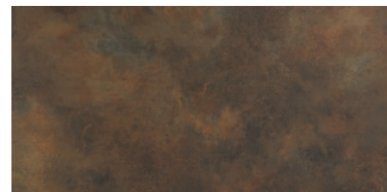

NERO GRECO **BSP-21**

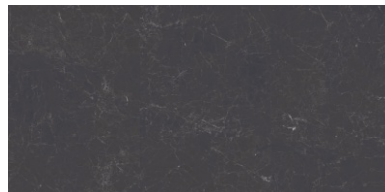

NATURE MOOD TUNDRA **BSP-62**



COLORS OF CABINET BODIES AND FRONTS / KOLORYSTYKA KORPUSÓW SZAFEK I FRONTÓW

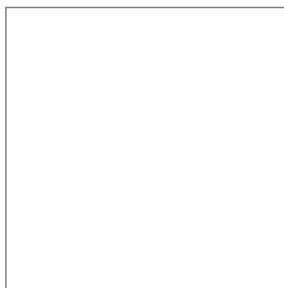

PLA-01
BIANCO SOFT TOUCH



PLA-02
GRIS SOFT TOUCH



PLA-03
ANTRACITE SOFT TOUCH



PLA-04
NEGRO SOFT TOUCH

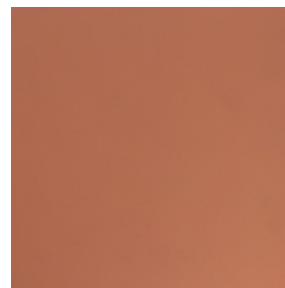

PLA-05
METAL COPPER SOFT TOUCH



PLA-06
METAL GOLD SOFT TOUCH



ALUMINUM FRONTS / FLAPS WITH
TRANSPARENT GLASS
AVAILABLE IN THREE COLORS

FRONTY / KLAPY ALUMINIOWE
ZE SZKŁEM PRZE ROZCZYSTYM
DOST PNE W TRZECH KOLORACH



BSZ-03
ANTISOL GLASS BROWN 8 mm
SZKŁO ANTISOL BR Z 8 mm



BSZ-04
ANTISOL GLASS GRAPHIT 8 mm
SZKŁO ANTISOL GRAFIT 8 mm



BSZ-06
ANTISOL GLASS BLACK 8 mm
SZKŁO ANTISOL CZARNY 8 mm

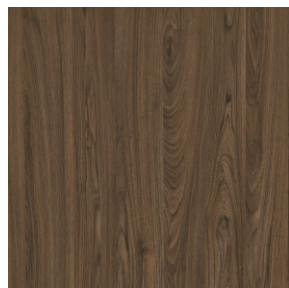

PLA-07
NOGAL ROSALES 03 STRUKTURA

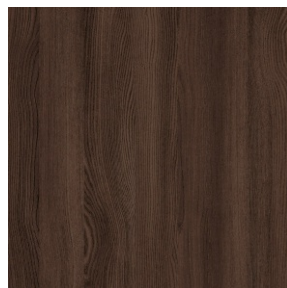

PLA-08
COMO ASH 03 STRUKTURA

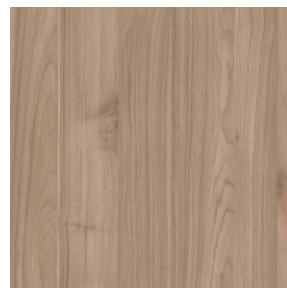

PLA-09
NOCCE 01 SYNCHRON

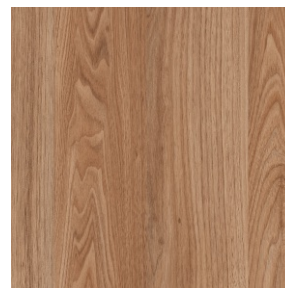

PLA-10
NOGAL ROSALES 02 STRUKTURA

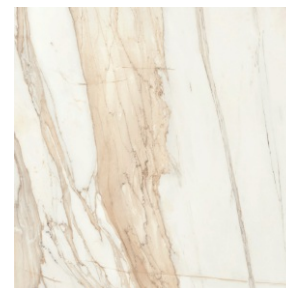

PLA-11
BERNINI SOFT TOUCH



PLA-12
TITAN 03 STRUKTURA



PLA-13
BETON CRT STRUKTURA



PLA-14
TEXTIL PLATA TST STRUKTURA



PLA-15
TEXTIL ORO TST STRUKTURA

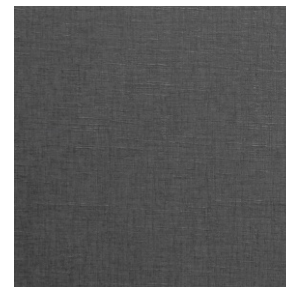

PLA-16
TEXTIL GRAFITO TST STRUKTURA

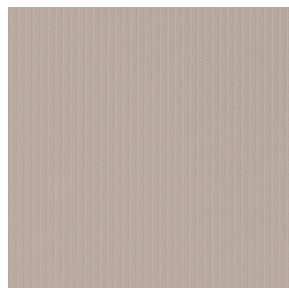

PLA-17 AV
VULCANO VERTICAL STRUKTURA

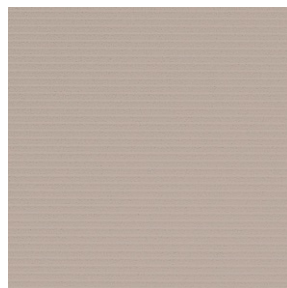

PLA-17 DY
VULCANO HORIZONTAL
STRUKTURA

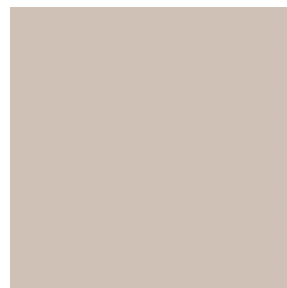

PLA-18
TAUPE SOFT TOUCH



PLA-19
BASALTO SOFT TOUCH

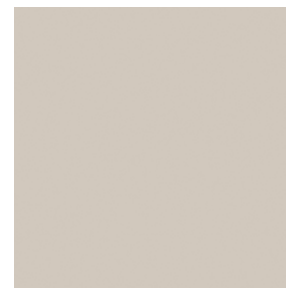

PLA-20
CASHMERE SOFT TOUCH



HIOORO

44-100 Gliwice ul. Łu ycka 16
Telefon: +48 692 528 588
o ce@hiooro.eu